



Rack Desmontável Padrão 19"

ITENS	DESCRIÇÃO	QTD.
01	BASE	01
02	TETO	01
03	QUADRO DE ESTRUTURA	02
04	SUORTE DO PLANO PADRÃO	06
05	TAMPAS LATERAIS	02
06	PORTA TRASEIRA	01
07	PORTA FRONTAL EM VIDRO	01
08	PLANO PADRÃO 19"	04
09	PÉ NIVELADOR	04
10	KIT RODÍZIO	04
11	FECHADURA ESCAMOTEÁVEL	01
12	FECHADURA CILÍNDRICA	01
13	KIT VENTILAÇÃO	01
14	CABO DE ATERRAMENTO	02
15	TAMPA DE FECHAMENTO PQ.	05
16	TAMPA DE FECHAMENTO GR.	04
17	BUCHA DE NYLON	04
18	CHAVE EM L	01
19	KIT DE MONTAGEM	01

01. BASE



x1

02. TETO

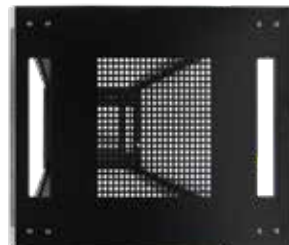

x1

03. QUADRO DE ESTRUTURA



x2

04. SUPORTE DO PLANO PADRÃO



x6

05. TAMPAS LATERAIS



x2

06. PORTA TRASEIRA



x1

07. PORTA FRONTAL



x1

08. PLANO PADRÃO



x4

09. PÉ NIVELADOR



x4

10. KIT RODÍZIO



x4

11. FECHADURA ESCAMOTEÁVEL



x1

12. FECHADURA CILÍNDRICA



x1

13. KIT EXAUSTOR



x1

14. CABO DE ATERRAMENTO

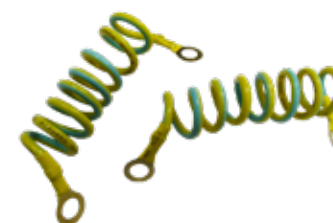

x2

15. TAMPA DE FECHAMENTO PQ.



x5

16. TAMPA DE FECHAMENTO GR.



x4

17. BUCHA DE NYLON GR.



x4

18. CHAVE EM L



x1

19. KIT DE PARAFUSOS PARA MONTAGEM



x1

1.



Fixe os pés niveladores na base do Rack

2.



Fixe os Quadros de Estrutura na base do Rack utilizando a chave em L

Obs: Os recordes de encaixe das longarinas laterais devem ficar nas extremidades externas do rack

3.



Fixe o teto do Rack nos Quadros de Estrutura utilizando a chave em L

4.



Deite o Rack cuidadosamente e instale o Kit rodízio

5.

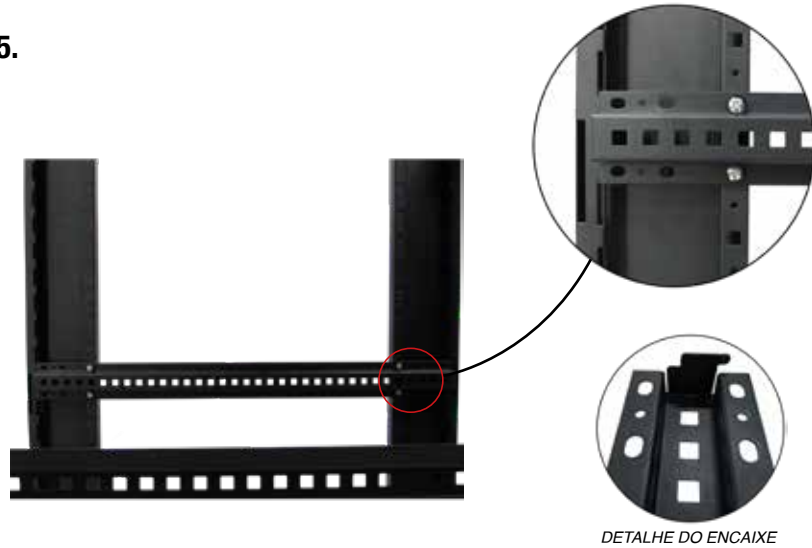

Fixe as longarinas laterais na estrutura do rack, encaixando-as nos recortes da estrutura frontal e traseiras das extremidades externas.

6.

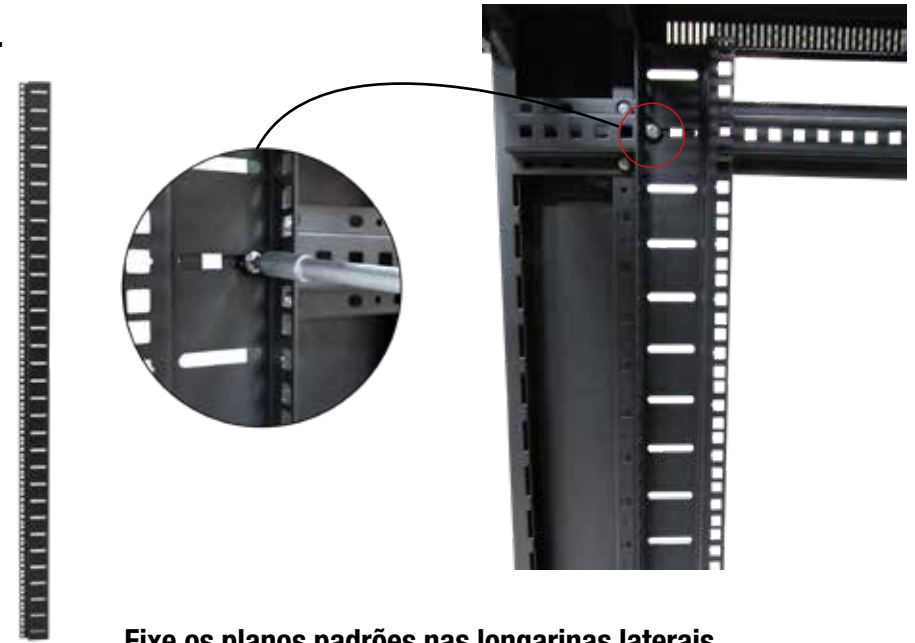

Fixe os planos padrões nas longarinas laterais

7.



Encaixe as tampas laterais do Rack pressionando os botões

8.



Encaixe as buchas de nylon nas perfurações onde vão os pinos da porta. Encaixe a porta traseira no Rack, fixando primeiramente o pino inferior na bucha e depois o superior

9.



Pino de fixação da porta



Buchas de Nylon da parte superior e inferior da porta

Encaixe as buchas de nylon nas perfurações onde vão os pinos da porta. Encaixe a porta frontal no Rack, fixando primeiramente o pino inferior na bucha e depois o superior

10.

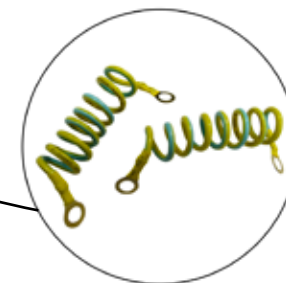

Instale o aterramento frontal e traseiro

11.



Desparafuse o suporte de fixação da fechadura, encaixe a fechadura na porta frontal do rack, e fixe novamente o suporte de fixação.



Instale a fechadura escamoteável na porta frontal

12.



Desparafuse o suporte de fixação da fechadura, encaixe a fechadura na porta frontal do rack, e fixe novamente o suporte de fixação.

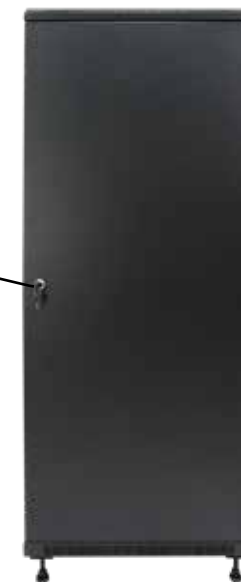

Instale a fechadura cilíndrica na porta de trás

13.

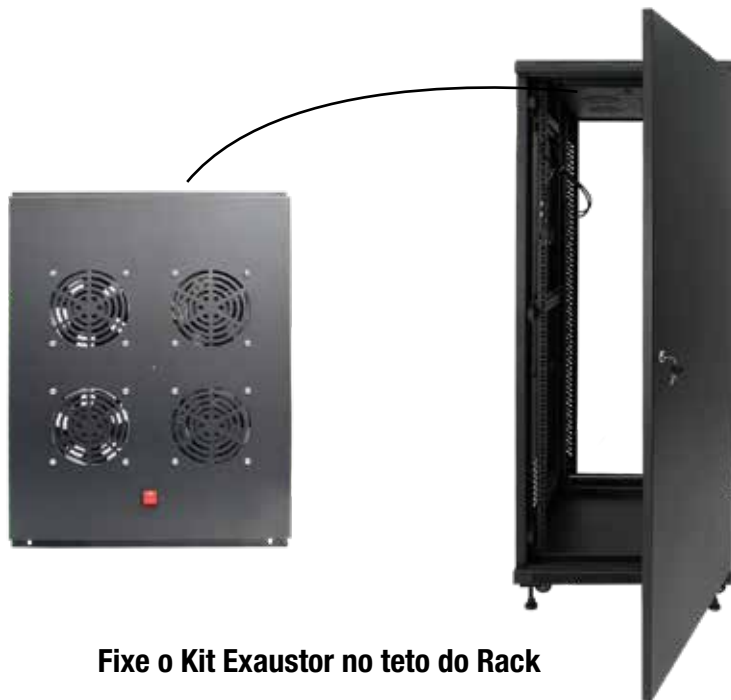

Fixe o Kit Exaustor no teto do Rack

14.

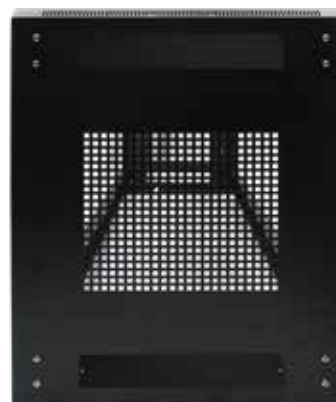

Tampas de fechamento no teto



Tampas de fechamento na base

Caso não tenha cabos entrando no Rack, utilize os painéis de fechamento para fechar as aberturas do Rack

CERTIFICADO DE QUALIDADE

